

- Modular cores snap in and out to create 1, 2, 3, or 4-way air pattern without the use of special tools
- Perforated face has 3/16" diameter holes on 1/4" staggered centers (51 % free area)
- Optional opposed blade damper (SOBD) is shipped loose and field mounted
- **PM** - steel construction
- **APM** - aluminum construction
- Standard finish is white (WH)

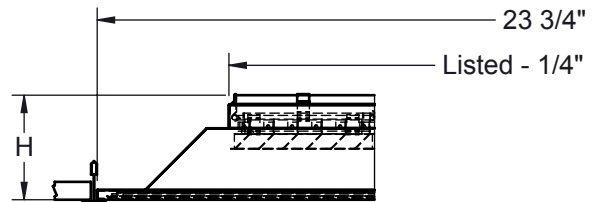

Margin LT, Lay-in T-Bar

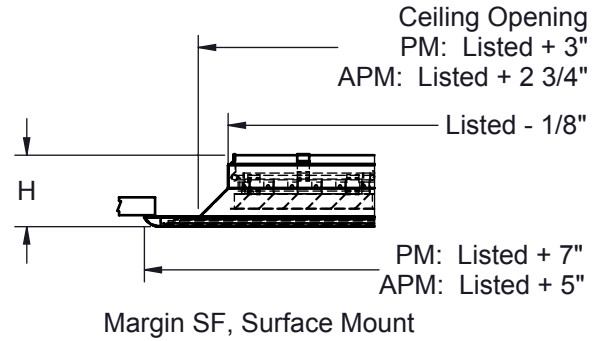
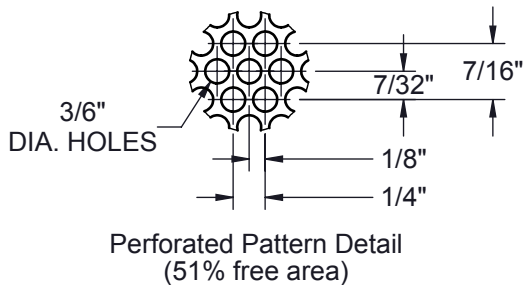
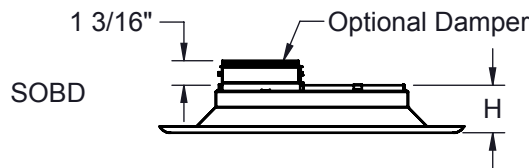
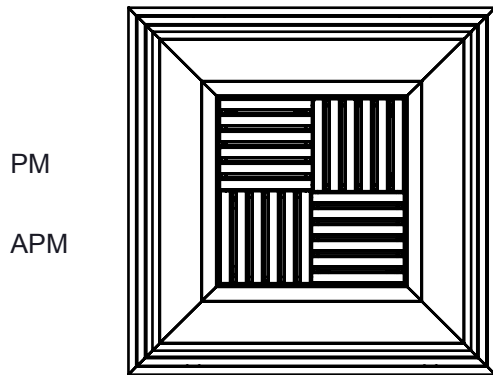
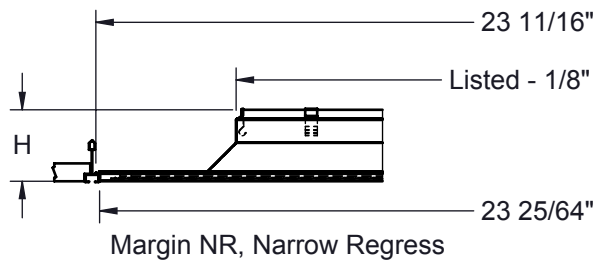
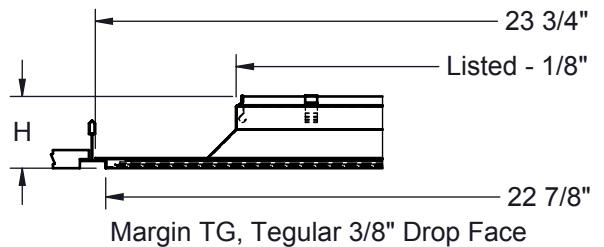

PM, Dimension H			
SF	LT	TG	NR
2 5/8"	4"	2 5/8"	2 5/8"
APM, Dimension H			
SF	LT	TG	NR
3"	2 7/8"	2 7/8"	2 7/8"

Dimensions in inches

Job: \_\_\_\_\_  
Location: \_\_\_\_\_  
Architect: \_\_\_\_\_  
Engineer: \_\_\_\_\_  
Contractor: \_\_\_\_\_

Tag: \_\_\_\_\_  
Submitted By: \_\_\_\_\_  
SD - 1783    Rev: A (10/12)

**PM, APM Square Neck  
Perforated Supply  
with Modular Core**