

- Face mounted adjustable pattern deflectors
- Hinged / removable face allows for easy access to damper
- Optional round damper is shipped loose and field mounted
- Model **PP** is all steel construction
- Model **APP** is steel backpan with aluminum face
- Standard finish is white

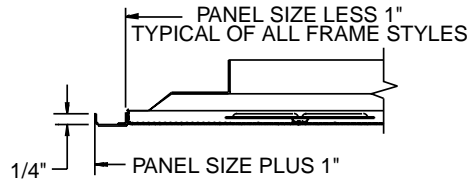

**Frame SF (Surface Mount)**  
\*minimum ceiling opening 23-1/4"

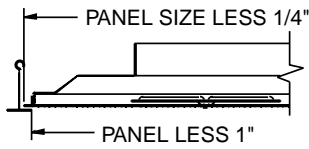

**Frame LT (Lay-in T-Bar)**

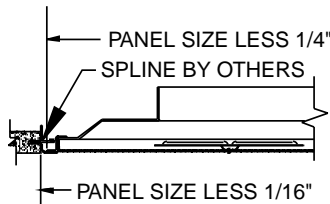

**Frame PL (Spline)**

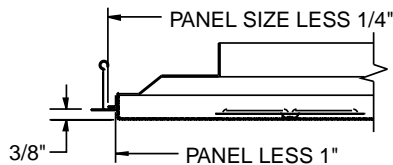

**Frame TG\*\* (Tegular)**

**\*\*NOTE:** Frame TG not available for Model APP

**Frame Detail:**  
24 x 24 Module Size

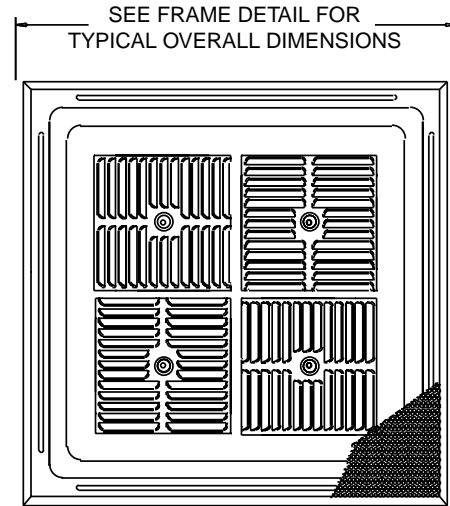

**PP**     **APP**

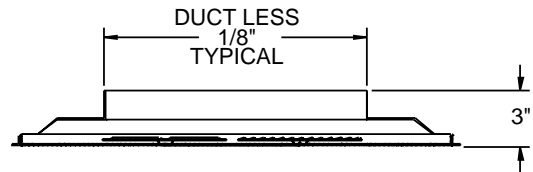

**Side View Detail, LT Frame**

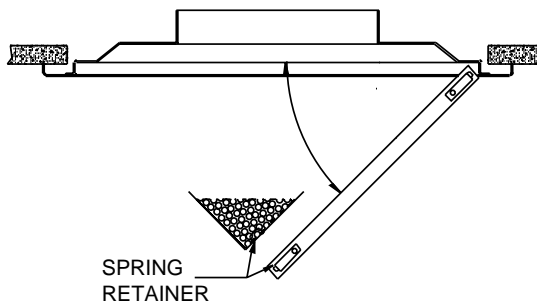

**Face Hinge Detail**

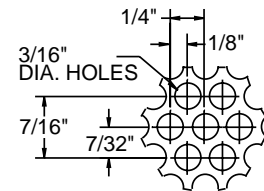

**Perforated Pattern Detail**  
(51% free area)

Dimensions are in inches. Product information subject to change without notice.

PROJECT:	SUBMITTED BY:	DATE: 7/02/01	SD - 1777
ARCHITECT:		<b>PP, APP Round Neck</b>	
ENGINEER:		Perforated Supply	
CONTRACTOR:		Face Mounted Deflectors	
LOCATION:		24 x 24 Module Size	