

- Face mounted adjustable patten deflectors
- Hinged / removable face allows for easy access to damper
- Optional square damper is shipped loose and field mounted
- Model **PP** is all steel construction
- Model **APP** is steel backpan with aluminum face
- Standard finish is white

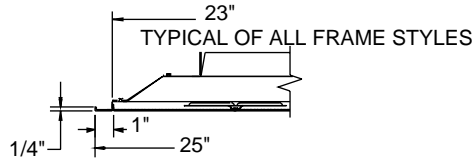

Frame SF (SurFace Mount)
*minimum ceiling opening 23-1/4"

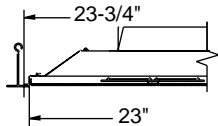

Frame LT (Lay-in T-Bar)

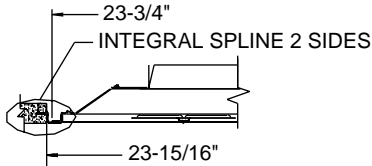

Frame PL (Spline)

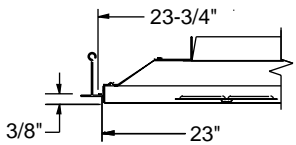

Frame TG (Tegular)**

**NOTE: Frame TG not available for Model APP

Frame Detail:
12x12, 16x16, 20x20,
24x12, and 48x24
Module Sizes

SEE FRAME DETAIL FOR
TYPICAL OVERALL DIMENSIONS

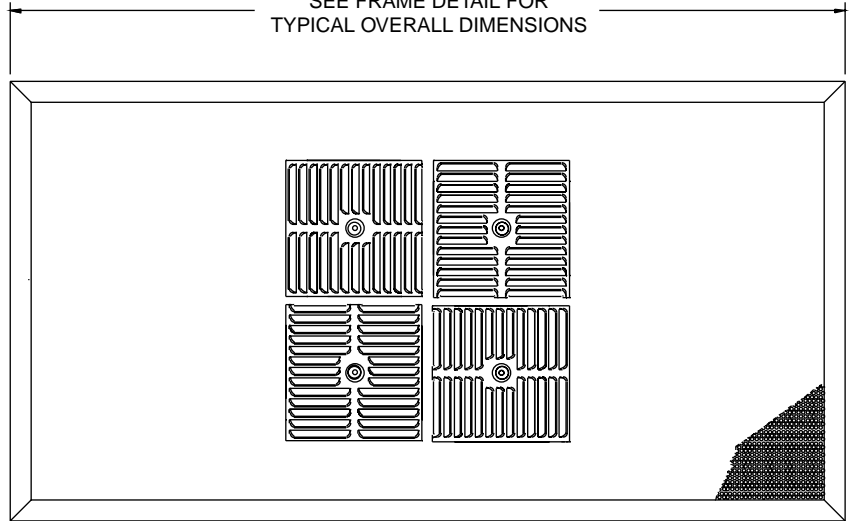

PP **APP**

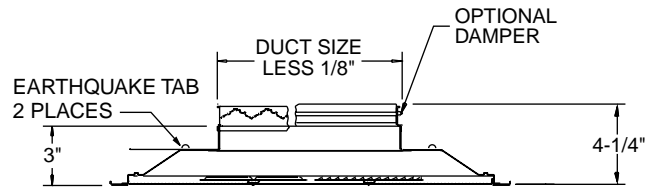

Side View/Damper Detail, SF Frame

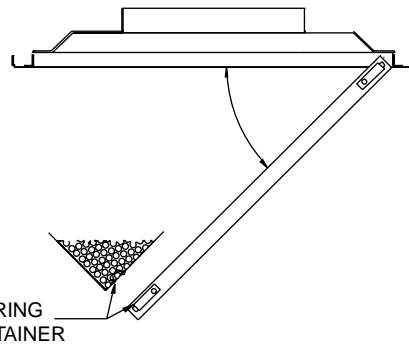

Face Hinge Detail

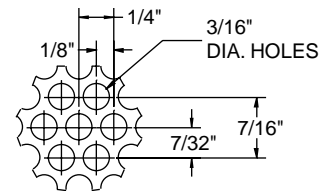

Perforated Pattern Detail
(51% free area)

Dimensions are in inches. Product information subject to change without notice.

PROJECT:	SUBMITTED BY:	DATE: 7/02/01	SD - 1776
ARCHITECT:		PP, APP Square Neck	
ENGINEER:		Perforated Supply	
CONTRACTOR:		Face Mounted Deflectors	
LOCATION:		Additional Module Sizes	