

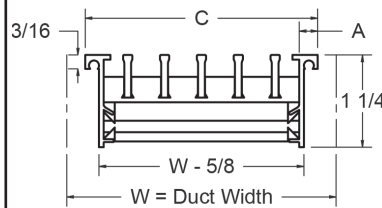

ARCHITECTURAL STYLES

4000 Series

Available Cores

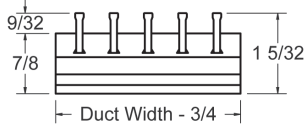
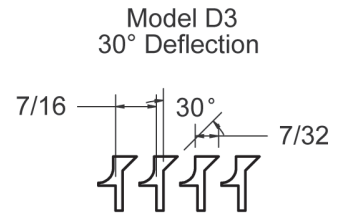
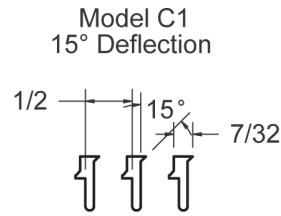
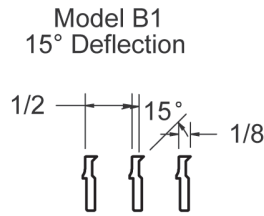
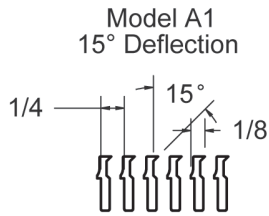
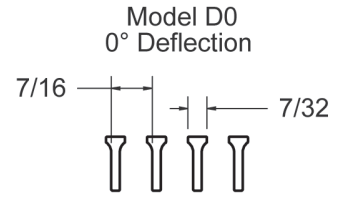
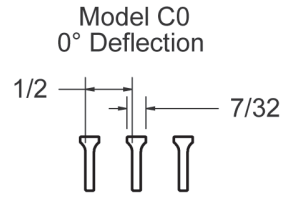
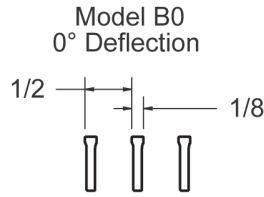
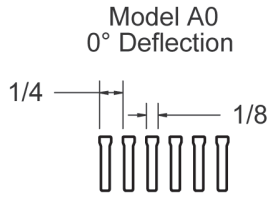

Margin Style	A	B	C
025	1/4	L - 1/4	W - 1/4
050	1/2	L + 1/4	W + 1/4
075	3/4	L + 3/4	W + 3/4
100	1	L + 1 1/4	W + 1 1/4
125	1 1/4	L + 1 3/4	W + 1 3/4

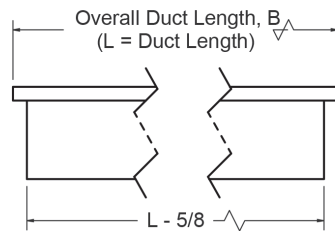
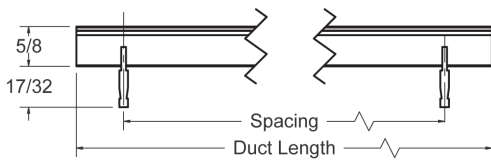

Core Only

Margins Only

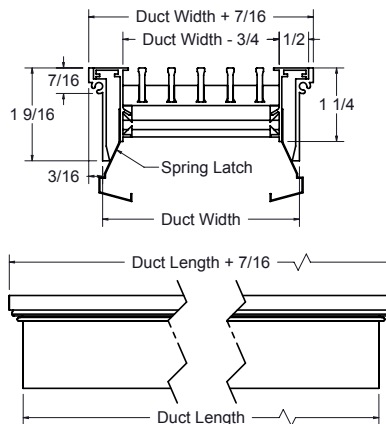
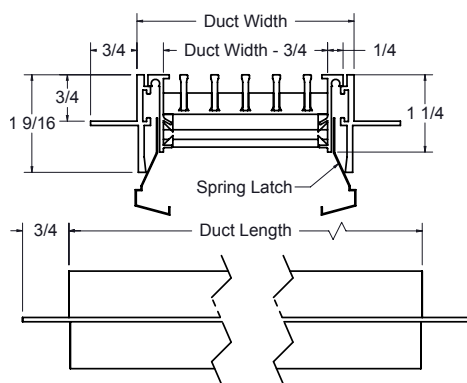

1SL

2SL

Linear/
Slot Diffusers



PRODUCT DIMENSIONS

4000 Series

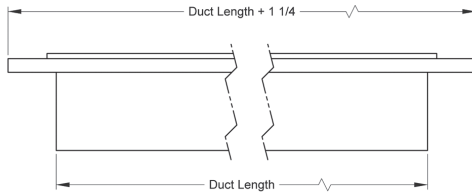
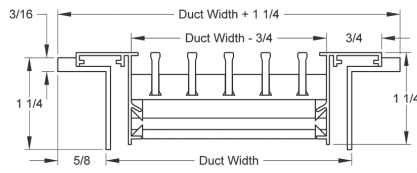

400

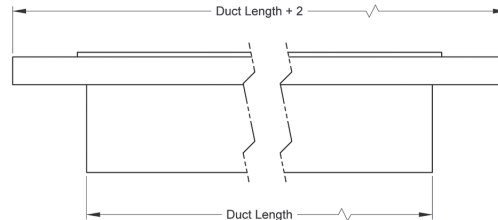
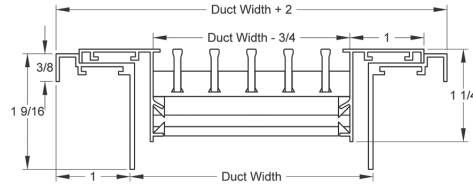

500

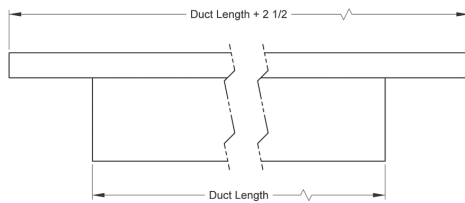
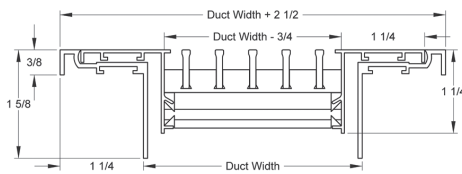

600

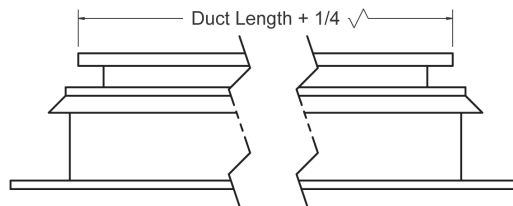
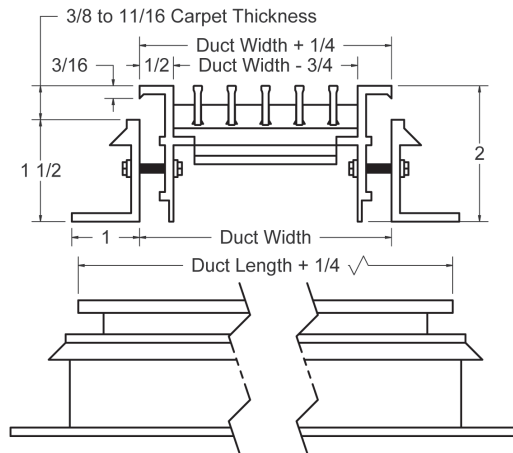

700

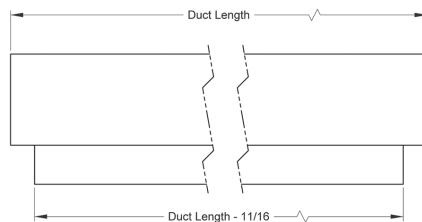
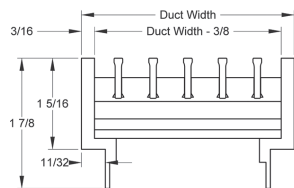

800

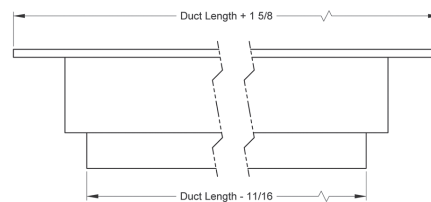
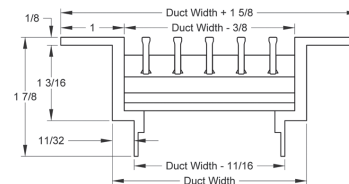

900

Note: 9SH with Screw Holes



PRODUCT DIMENSIONS

4000 Series Fastening & Mounting

Type 0SH - Screw Holes
(Not For Use with Margin 025)



Type 0SP - Spring Clip
(Not for Use with Margin 025)



CMB - Concealed
Mounting Brackets
(Not Available on Core A0/A1)

