

PRODUCT DIMENSIONS

T70, T70D, T75, T75D

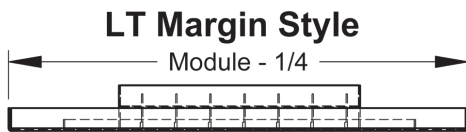
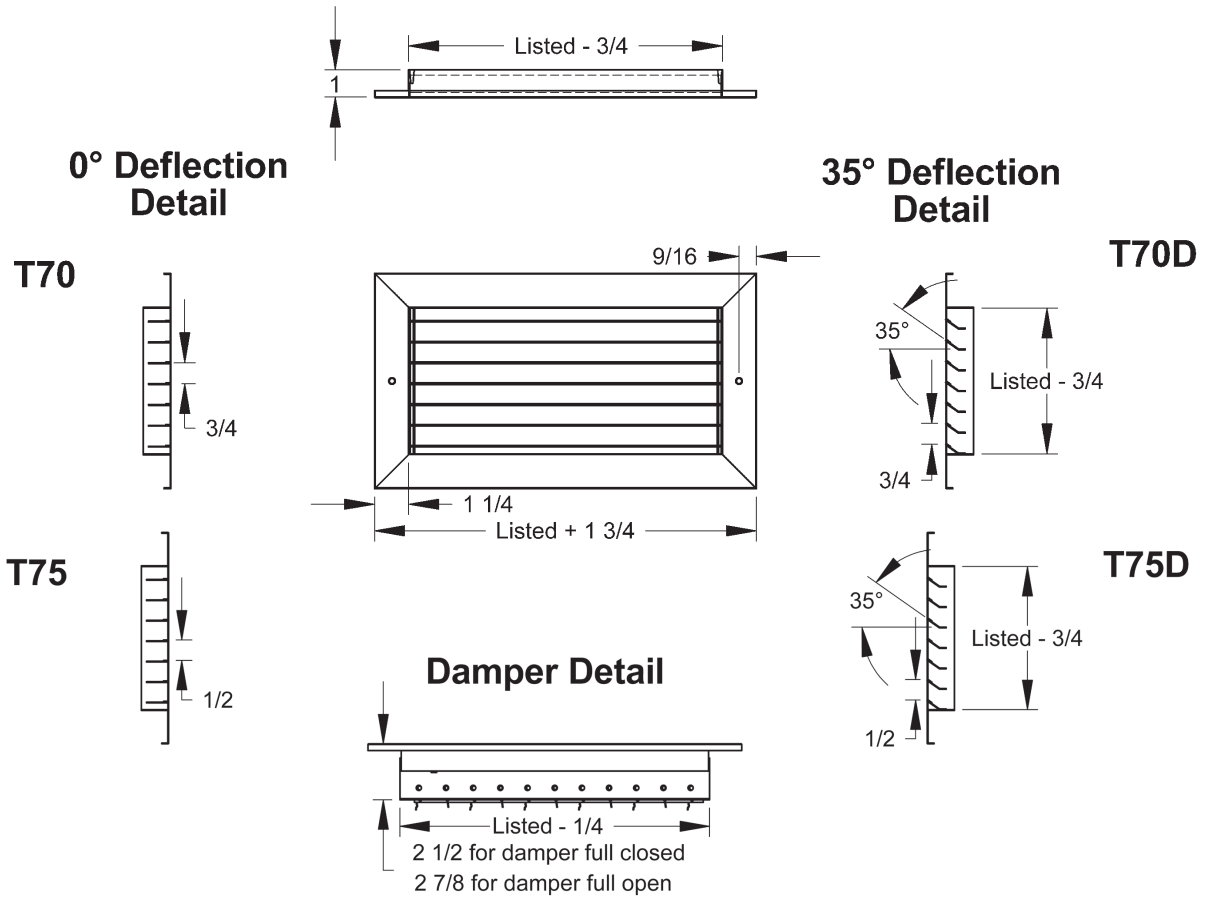

Module	* Max Neck
12x12	9x9
24x12	21x9
24x24	21x21
48x24	45x21

Concealed Mounting

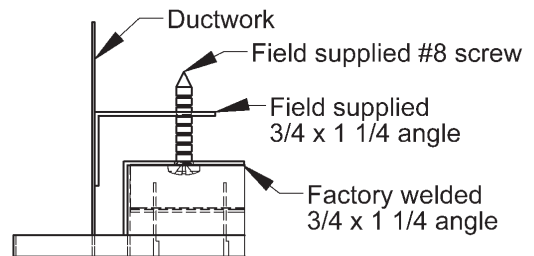

*When using a module for Lay-in T-Bar ceiling, this is the maximum neck size for specified module

PRODUCT DIMENSIONS

T80, T80D, T85, T85D



T80 (0° Deflection)

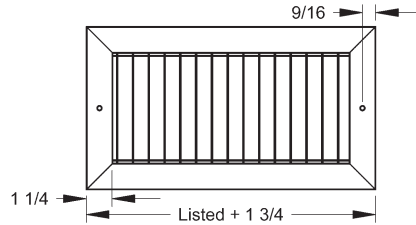
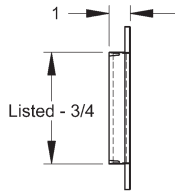
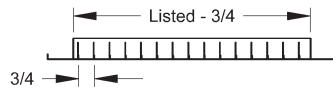

Damper Detail

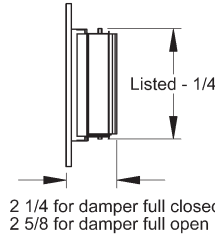

T80D (35° Deflection)

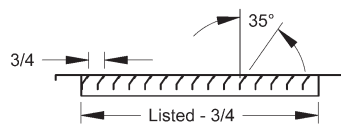

T85 (0° Deflection)

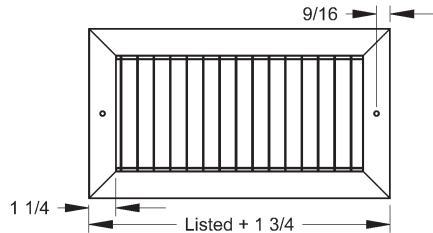
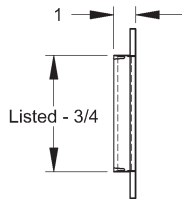
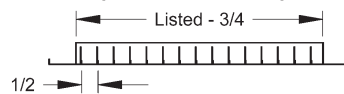

Damper Detail

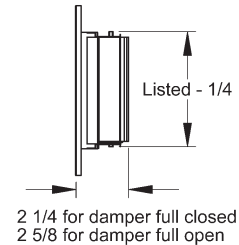

T85D (35° Deflection)

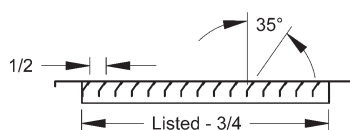

LT Margin Style

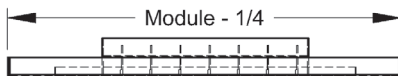

Module	* Max Neck
12x12	9x9
24x12	21x9
24x24	21x21
48x24	45x21

Concealed Mounting

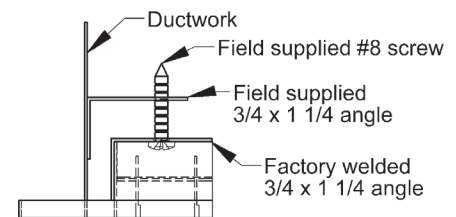

*When using a module for Lay-in T-Bar ceiling, this is the maximum neck size for specified module

DIMENSIONS IN INCHES